

**SERBATOIO HUSQVARNA 15 L**

**FUEL INJECTED FC 16/17 FE 2017**

COD. 500005677 REV.1

ACERBIS PARTS	O.E.M ITEMS TO USE:	ACERBIS PARTS ONLY FOR US TANKS
<p><b>A</b> - (1 pcs.)</p> <p><b>B</b> - (1 pcs.)</p> <p><b>C</b> - (1 pcs.)</p> <p><b>N</b> - (4 pcs.)</p>	<p><b>I</b> - (1 pcs.)</p> <p><b>F</b> - (1 pcs.)</p> <p><b>H</b> - (1 pcs.)</p> <p><b>G</b> - (1 pcs.)</p> <p><b>D</b> - (5 pcs.)</p> <p><b>E</b> - (6 pcs.)</p>	<p><b>G</b> - (1 pcs.)</p> <p><b>F</b> - (1 pcs.)</p> <p><b>E</b> - (2 pcs.) k60x20</p> <p><b>D</b> - (5 pcs.)</p> <p><b>L</b> - (1 pcs.)</p> <p><b>M</b> - (4pcs.) k60x25</p>

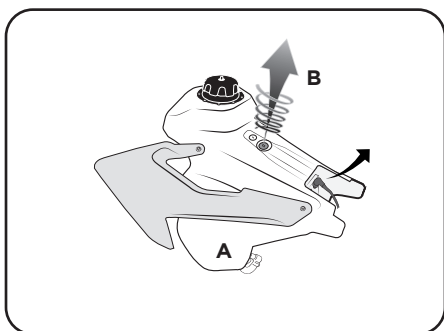

**1.** Svitare la vite serbatoio B. Sconnettere il cavo di alimentazione della pompa.  
**Remove the tank screws B. Disconnect the fuel pump power cable.**

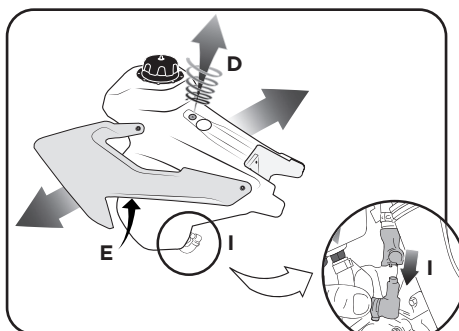

**2.** Rimuovere i fianchetti, la vite-sella D ed il serbatoio Husqvarna.  
**Remove the radiator scoops, the seat screw D, and the Husqvarna tank.**

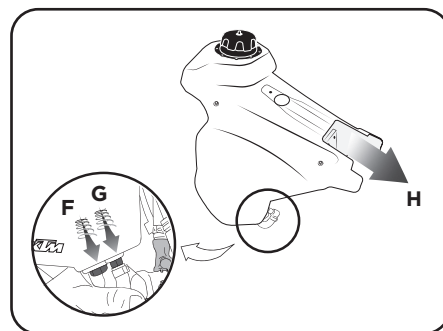

**3.** Svuotare completamente la benzina dal serbatoio, rimuovere le utenze F/G e scollegare il connettore benzina svitando le quattro viti pompa H.  
**Empty your fuel tank completely, remove the fasteners F/G and the disconnect the fuel connector by unscrewing the four pump screw H.**

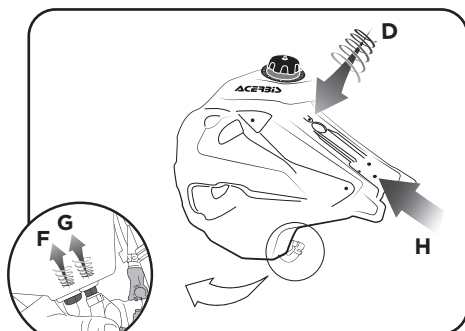

**4.** Mettere la vite-sella D (2,5KN - 22INH) le utenze F/G sul serbatoio Acerbis e ricollegare il connettore benzina H tramite le quattro viti pompa M (3KN - 26INH).  
**Insert the seat screw D (2,5KN - 22INH), fasteners F/G on the Acerbis fuel tank and reconnect the fuel connector H by screwing the four pump screw M (3KN - 26INH).**

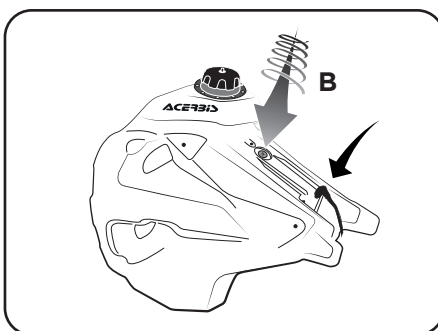

**5.** Posizionare il serbatoio sulla moto, riconnettere il cavo di alimentazione della pompa e riavvitare la vite-serbatoio B.  
**Arrange the tank on the bike, reconnect the fuel pump power cable and screw the tank screw B back on.**

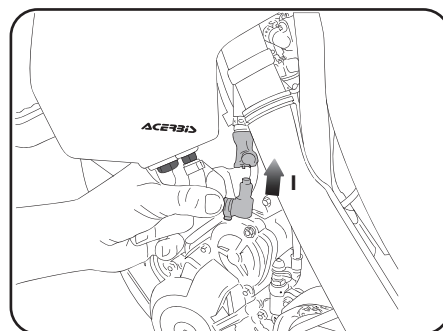

**6.** Riconnettere connettore benzina.  
**Reconnect the fuel connector.**

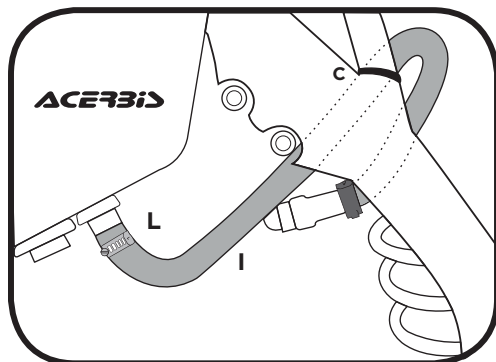

**ATTENZIONE: Dettaglio montaggio tubo-pompa**  
**ATTENTION: Pump hose mounting detail**

Fissare il tubo pompa HUSQVARNA nel modo indicato: usare la fascetta C Acerbis in dotazione facendo attenzione che il tubo piegandosi non crei strozzature.  
**Fix the pump hose HUSQVARNA as illustrated: use the Acerbis strap C included make sure that the hose doesn't fold obstructing the fluid.**

**SERBATOIO HUSQVARNA 15 L**

**FUEL INJECTED FC 16/17 FE 2017**

COD. 500005677 REV.1

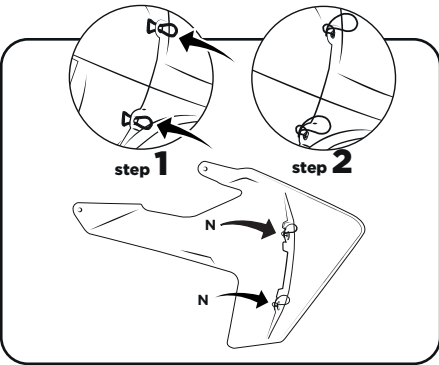

**7.** Allacciare gli O-ring N ai fianchetti nel modo indicato.  
**Fasten the O-rings N to the radiator scoops, as shown.**

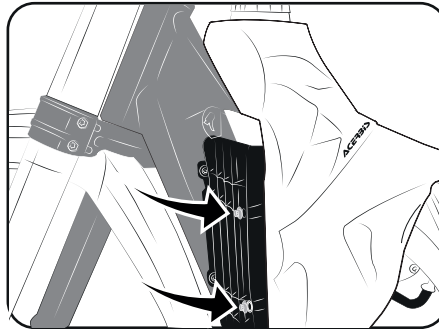

**8.** Avvitare le viti di fissaggio ai radiatori.  
**Tighten the screws to the radiators.**

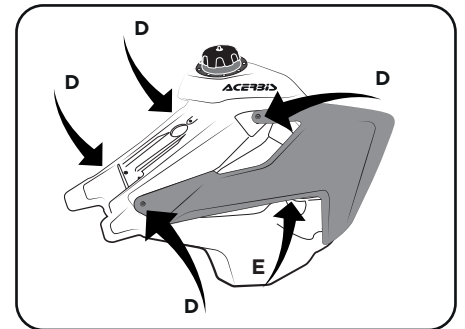

**9.** Rimontare i fianchetti con le 4 viti D e le 2 viti E.  
**Remounting the radiator scoops with 4 screws D and 2 screws E.**

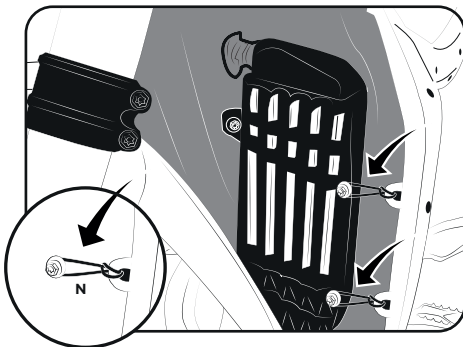

**10.** Fissare anteriormente gli O-ring N alle viti precedentemente installate.  
**Fasten the O-rings N on the screws previously installed.**

**DISCLAIMER:**

DISCLAIMER: Due to uncontrolled variables in the manufacturing process of rotationally molded fuel tanks, the fuel tank may vary in size and shape by up to 7% of the manufacturer's original listed capacity.

**LIBERATORIA**

LIBERATORIA: A causa di variabili inponderabili nel processo di stampaggio rotazionale dei serbatoi, questi possono differire in forma e dimensioni fino al 7% rispetto alla capacità dichiarata.

**FOR COMPETITION USE ONLY  
SOLO PER USO AGONISTICO**



Thank you for purchasing an ACERBIS fuel tank

**WARNING**

It is **EXTREMELY IMPORTANT** that the fuel tank be properly installed. To ensure proper installation, it is **STRONGLY RECOMMENDED** that the tank be installed only by a qualified OEM licensed dealership mechanic. Improper installation could result in serious injury or even death.

**If self-installed NOTE THE FOLLOWING.** Particular attention must be paid to excessive fuel line length and fuel line proximity to hot engine areas and pipes to prevent fire.

Clean tank interior thoroughly before installation. Install this fuel tank only in a well ventilated area, as gasoline fumes are extremely dangerous. Do not start or operate the vehicle if there are any fuel leaks! Read all instruction first before beginning installation.

**DISCLAIMER**

Due to uncontrolled variables in the manufacturing process of rotationally molded fuel tanks, the fuel tank may vary in size and shape by up to 7% of the manufacturer's original listed capacity.